



TL1250P-850C N6 CS 4K Resolution Day/Night lens for 1/1.7\" sensors

- ✓ Ultra high resolution for 4K cameras, up to 12.4 megapixel, 300 lp/mm
- ✓ P-iris (stepper motor) for precise aperture control
- ✓ Fully motorized with zoom, focus, iris, IR cut, and limit switches
- ✓ Optional motor control board (MCR600 or MCR400) available for easy integration
- ✓ IR corrected for true Day/Night cameras
- ✓ Compact design to fit into domes as small as 4\" mini-dome size
- ✓ CS-mount
- ✓ Used for sensor sizes 1/2.5\", 1/2.3\", 1/2\", 1/1.8\", and up to 1/1.7\" (Sony IMX178, Sony IMX226 for example)

TL1250 lens specifications

| | |
|-------------------------|---------------------------------------------|
| Focal length (FL) | 12-50mm |
| Mount type | CS-mount |
| Iris type | P-iris |
| Image circle | Ø9.4mm at FL 12mm |
| Resolution | 12.4 megapixel, 300 lp/mm |
| F/# | F/1.8 @ 12mm - F/2.4 @ 50mm to close |
| IR Correction | 435nm – 940nm (Day/Night) |
| Focus Range | 2.0m - infinity |
| Lens length (TTL) | 64mm TTL |
| Back focal length (BFL) | 8.2mm (in air) |
| Chief ray angle (CRA) | < 7° |
| Geometric distortion | < 10% at 12mm, < 2% at 50mm |
| Relative illumination | >40% |
| Lens transmission | >80% |
| Weight | 74g |
| Operating temperature | -20C to 60C (<70% humidity, non-condensing) |
| Storage temperature | -30C to 70C (<90% humidity, non-condensing) |

Field of view for sensor sizes (12mm – 50mm)

| Sensor size | 1/1.7\" | 1/1.8\" | 1/1.8\" 4K* | 1/2\" | 1/2.3\" | 1/2.5\" |
|-------------|------------|------------|----------------|------------|------------|------------|
| Horizontal | 36° - 8.6° | 36° - 8.6° | 35° - 8.5° | 30° - 7.4° | 30° - 7.2° | 27° - 6.7° |
| Vertical | 26° - 6.5° | 23° - 5.8° | 17° - 4.3° | 23° - 5.6° | 22° - 5.5° | 20° - 5.0° |
| Diagonal | 46° - 11° | 44° - 10° | 40° - 9.5° | 39° - 9.2° | 38° - 9° | 34° - 8.3° |

*4K format = 4000 x 2000 pixels



Lens drawing

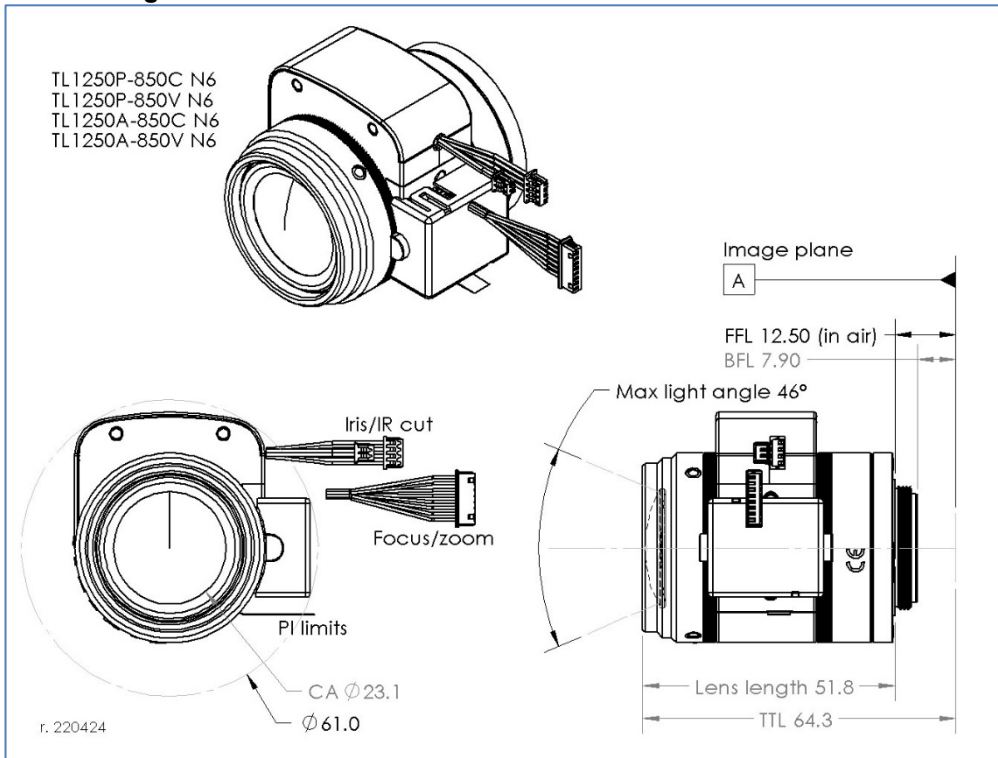

CAD models can be downloaded from TheiaTech.com/1250CAD

Entrance pupil location

The entrance pupil location is located inside the lens and for the longer focal length, even behind the image sensor position. It is measured from the vertex of the lens at the input side. The lens vertex is 0.5mm below the plastic front ring of the lens.

| Focal Length | Entrance Pupil Location (mm) |
|--------------|------------------------------|
| 12 | 26.35 |
| 15 | 31.88 |
| 20 | 43.18 |
| 25 | 52.97 |
| 30 | 61.65 |
| 35 | 69.40 |
| 40 | 76.08 |
| 45 | 81.49 |
| 50 | 89.85 |

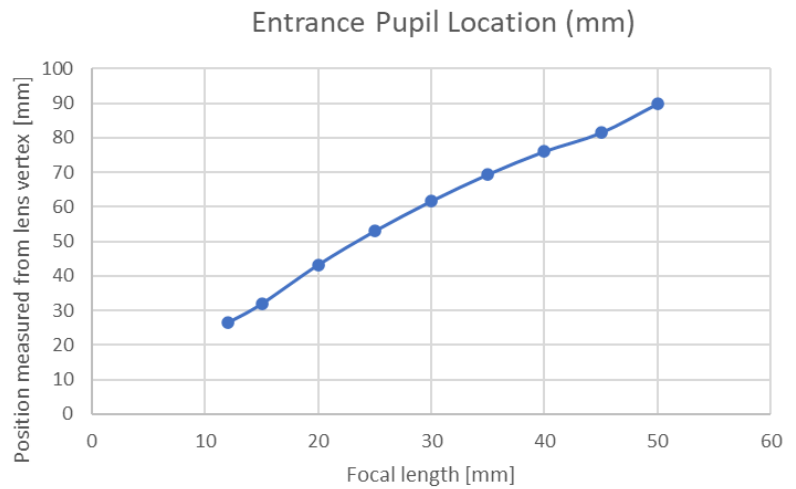

Zoom/Focus motor specifications

| | |
|----------------------------|---------------------------------------------------------|
| Drive | Stepper motor 2 phase bipolar drive |
| Operation voltage | 3.3V (2.5-3.5V range) |
| Maximum motor temperature* | Do not let motor temperature exceed 120°C |
| Coil resistance | 30.0Ω |
| Zoom number of steps | 3227 steps between hard stops |
| Zoom speed range** | Up to 1200pps |
| Zoom cam rotation | 75° |
| Focus number of steps | 8390 steps between hard stops |
| Focus speed range** | Up to 1200pps |
| Focus cam rotation | 195° |
| Focus/zoom connectors | Housing: Molex 51021-0800 Terminal: Molex 50058-8000 |
| Cable length | 150mm |

| Zoom: Wide -> Tele | | | | |
|--------------------|----|----|----|----|
| Focus: Near -> ∞ | | | | |
| Step | A+ | A- | B+ | B- |
| 0 | H | L | H | L |
| 1 | L | H | H | L |
| 2 | L | H | L | H |
| 3 | H | L | L | H |

| Pin | Color | Function | Motor |
|-----|--------|----------|-------|
| 1 | Brown | A+ | Focus |
| 2 | Red | A- | Focus |
| 3 | Orange | B+ | Focus |
| 4 | Yellow | B- | Focus |
| 5 | Brown | A+ | Zoom |
| 6 | Red | A- | Zoom |
| 7 | Orange | B+ | Zoom |
| 8 | Yellow | B- | Zoom |

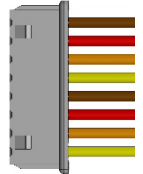

*Theia's motor temperature calculator can be used to estimate the focus and zoom motor temperatures after a set number of run/ cool down cycles. This can be downloaded from Theia's website (see the QR code below). These motorized lenses are **not intended for continuous use** of the motors as in PTZ applications due to potential over-heating of the lens motors.

The example below shows 60C ambient temperature and 3.5V motor. The motor is driven for 30 seconds (which would generally be longer than normal) with 10 seconds cool down between moves. After 3 moves, the motor is allowed to cool down which takes about 3 minutes.

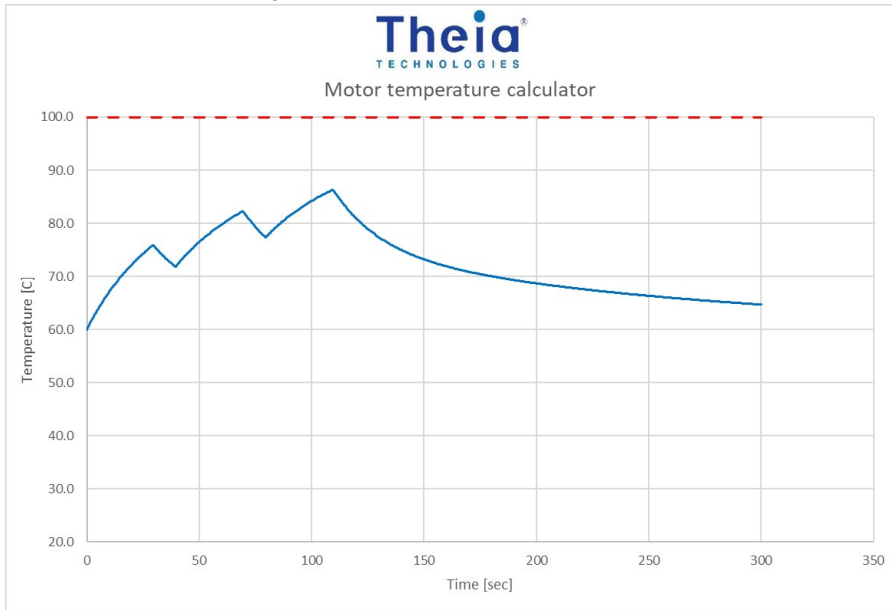

Motor temperature calculator
TheiaTech.com/calculators

**Zoom and focus motor positions may be affected by backlash and lost steps during movement. Lost steps are affected by the driving conditions. It is best to drive the motor between 200pps and 1200pps with 4-12 steps of acceleration/deceleration. Acceleration is especially helpful at higher driving speeds. Within these limits, the lost steps should be <5 steps per full zoom/focus range.

Backlash is variable from lens to lens but should be consistent for each movement of the lens motors. For zoom, expected backlash is approximately 15-20 steps and for focus it is approximately 30-40 steps.

Zoom/Focus motor key steps.

| <i>Zoom motor</i> | | <i>Focus motor</i> | |
|----------------------|-------------|--------------------|-------------|
| <i>Note</i> | <i>Step</i> | <i>Note</i> | <i>Step</i> |
| Hard stop (wide) | 3227 | Hard stop (far) | 8390 |
| Wide design position | 3227 | | |
| PI position | 3119 | PI position | 7959 |
| Tele design position | 0 | | |
| Hard stop (tele) | 0 | Hard stop (near) | 0 |

Zoom/Focus synchronizing map (observe min/max motor speeds). Due to internal lens variations and back focal length variations in the camera the observed focus motor step will be different than the design position shown below. The motor positions should be calibrated at several zoom/focus positions so these calibrated values can be used to offset the design curve at the set focal lengths to find the corrected zoom/focus curve for the lens.

| <i>Focal length</i> | <i>Zoom motor note</i> | <i>Zoom motor step number</i> | <i>Focus motor step number</i> |
|---------------------|------------------------|-------------------------------|--------------------------------|
| <i>[mm]</i> | | <i>[#]</i> | <i>[#]</i> |
| 12.36 | Wide end | 3227 | 3008 |
| 14.83 | | 2710 | 2117 |
| 18.05 | | 2194 | 1356 |
| 22.28 | | 1678 | 895 |
| 27.86 | | 1161 | 1046 |
| 35.20 | | 645 | 2413 |
| 49.00 | Tele end | 0 | 8067 |

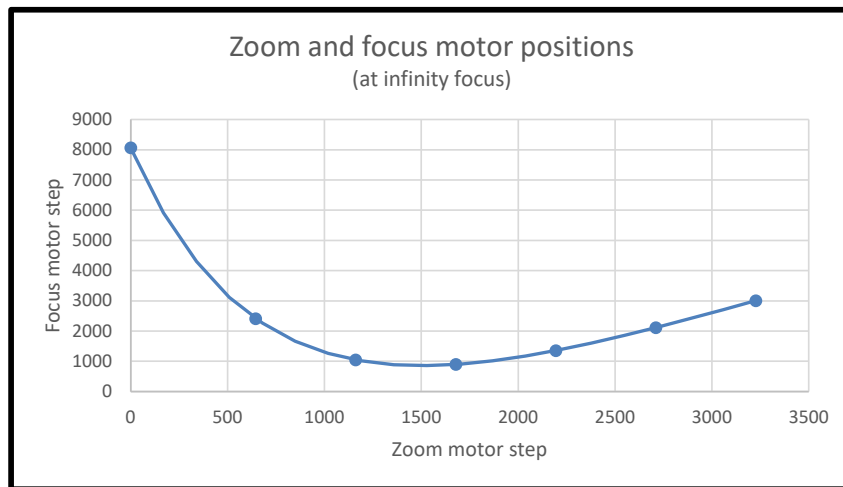

Notes:

These motorized lenses are intended for integration into cameras and require motor drivers and controllers. Typically, Theia works with the camera manufacturer to ensure that the camera motor controller matches the lens. It is possible to supply your own motor controller, but Theia cannot guarantee that your motor controller will not damage the lens. Theia does not offer any warranty on the suitability of these motorized lenses for any particular camera. Theia offers motor control boards that are suitable to control motorized lenses with P-iris.

P-iris motor specifications

| | |
|------------------------|----------------------------------------|
| Drive | Stepper motor 2 phase bipolar drive |
| Operating voltage | 4V (+/-1) |
| Number of steps | 75 (open to closed) |
| Basic step angle | 18° |
| Maximum response freq. | 200pps |
| Coil resistance | 30Ω |

| P-iris: open->close | | | | |
|---------------------|----|----|----|----|
| Step | A+ | A- | B+ | B- |
| 0 | H | L | H | L |
| 1 | L | H | H | L |
| 2 | L | H | L | H |
| 3 | H | L | L | H |

Connector type 1 (Molex)

| | |
|----------------|---------------------------------------------------------|
| Connector type | Housing: Molex 51021-0400 Terminal: Molex 50058-8000 |
| Cable length | 150mm |

| Pin | Color | Function |
|-----|--------|----------|
| 1 | Brown | B+ |
| 2 | Red | B- |
| 3 | Yellow | A+ |
| 4 | Orange | A- |

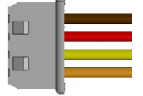

P-iris motor map

| Step | Aperture Size [mm ²] | F/# (at FL=12mm) |
|------|----------------------------------|------------------|
| 1 | 95.0 | 1.84 |
| 5 | 90.8 | 1.88 |
| 10 | 82.1 | 1.98 |
| 15 | 72.8 | 2.10 |
| 20 | 63.4 | 2.25 |
| 25 | 54.0 | 2.43 |
| 30 | 44.9 | 2.67 |
| 35 | 36.0 | 2.98 |

| Step | Aperture Size [mm ²] | F/# (at FL=12mm) |
|------|----------------------------------|------------------|
| 40 | 27.7 | 3.39 |
| 45 | 20.0 | 3.98 |
| 50 | 13.2 | 4.90 |
| 55 | 7.5 | 6.52 |
| 60 | 3.1 | 10.10 |
| 65 | 0.8 | 19.34 |
| 70 | 0.1 | 69.29 |
| 72 | 0.0 | Closed |
| 75 | 0.0 | Closed |

IR Cut/ selectable optical filter specifications

| Electrical specifications | |
|---------------------------|---------------------------------------------------------|
| Drive | DC |
| Operating voltage | 4.0V |
| Maximum switching time | 300ms |
| Drive coil resistance | 130Ω |
| Connector type | Housing: Molex 51021-0200 Terminal: Molex 50058-8000 |
| Cable length | 150mm |

| Mode | Pin 1 | Pin 2 |
|------------|-------|-------|
| Filter 1 | L | H |
| Filter 2 | H | L |
| Wire color | Red | Black |

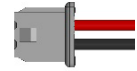

Filter optical specifications

The lens has 2 internal optical filters which can be selected electronically.

Clear glass filter

| | |
|----------|----------------------------------------------------------|
| Type | AR coated clear glass |
| Spectrum | 400 – 650nm: $t \geq 95\%$ 650 – 1050nm: $t > 93.5\%$ |

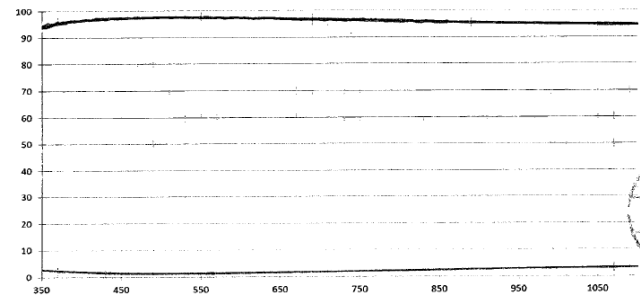

IR bandpass filter for 850nm illumination

| | |
|----------|---------------------------------------------------------------------------------------------------------------------------------------|
| Type | Notch filter for 850nm illumination |
| Spectrum | 400-700nm : $T < 5\%$ ave 820 +/- 10nm: $T = 50\%$ 850nm: $T \geq 93\%$ 880 +/- 10nm: $T = 50\%$ 900-1050 : $T < 5\%$ ave |

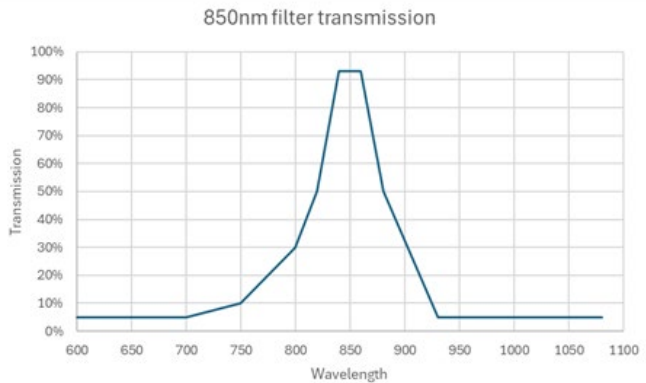

Zoom/Focus limit switch

| | |
|-------------------------------------------------|----------------------------------------------------------|
| Type | Photo interrupter phototransistor |
| Part model | Sharp GP1S396HCPSF |
| Operating voltage | 3.3V |
| Output level | >2.2V HIGH <0.6V LOW |
| Connector type | FPC cable |
| Board-side mating connector type (not supplied) | Molex 52746-0671 Molex 52745-0697 Molex 52559-0652 |
| Cable length | 150mm |

| Pin* | Function | Motor |
|------|-----------------|-------|
| 1 | Emitter | Focus |
| 2 | Anode/Collector | Focus |
| 3 | Cathode | Focus |
| 4 | Emitter | Zoom |
| 5 | Anode/Collector | Zoom |
| 6 | Cathode | Zoom |



*cable side pin designation matches Molex 52746-0671 bottom side contacts connector
Recommended circuit for each photo interrupter

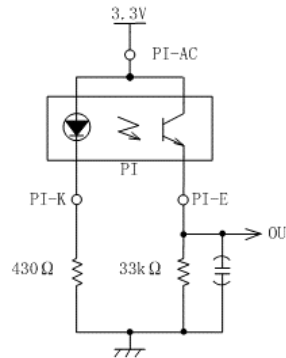

Alternate lens options

There are other lens configurations. The options listed in the table below may or may not be available. Please visit www.theiatech.com to learn more about our other lens options.

| Theia® PN | Varifocal | Mount type | Mount slip ring | Iris type | CCTV iris con. | Molex iris con. | IR corrected (day/night) | Visible bandpass filter | Clear filter (vis + IR) | 850nm bandpass filter | 940nm long pass filter | Zoom motor | Focus motor | PI limits | Focal length | MP rating | f/# | Image circle | Biggest sensor format | MOD [m] | Lens Length (to mount) | Lens Length (TTL) | Weight [g] |
|---------------------------------------------------|-----------|------------|-----------------|-----------|----------------|-----------------|--------------------------|-------------------------|-------------------------|-----------------------|------------------------|------------|-------------|-----------|--------------|-----------|-------|--------------|-----------------------|---------|------------------------|-------------------|------------|
| | | | | | | | | | | | | | | | | | | | | | | | |
| TL1250P N6-CS | ✓ | CS | ✓ | P | | ✓ | ✓ | ✓ | ✓ | | | ✓ | ✓ | PI | 12-50 | 12 (4K) | F/1.8 | 9.4 | 1/1.7" | 2 | 52 | 64.5 | 74 |
| TL1250P N6-25 | ✓ | 25 | | P | | ✓ | ✓ | ✓ | ✓ | | | ✓ | ✓ | PI | | | | | | | | | 76 |
| TL1250P N5-CS | ✓ | CS | ✓ | P | ✓ | | ✓ | | | | | ✓ | ✓ | PI | | | | | | | | | TBD |
| TL1250P-850V N6-CS | ✓ | CS | ✓ | P | | ✓ | ✓ | ✓ | ✓ | ✓ | | ✓ | ✓ | PI | | | | | | | | | 74 |
| TL1250P-850C N6-CS | ✓ | CS | ✓ | P | | ✓ | ✓ | ✓ | ✓ | ✓ | | ✓ | ✓ | PI | | | | | | | | | 74 |
| TL1250P-940V N6-CS | ✓ | CS | ✓ | P | | ✓ | ✓ | ✓ | | ✓ | ✓ | ✓ | ✓ | PI | | | | | | | | | 74 |
| TL1250P-940C N6-CS | ✓ | CS | ✓ | P | | ✓ | ✓ | ✓ | ✓ | ✓ | ✓ | ✓ | ✓ | PI | | | | | | | | | 74 |
| Related versions without motorized zoom and focus | | | | | | | | | | | | | | | | | | | | | | | |
| SL1250M | ✓ | CS | ✓ | M | | | ✓ | | | | | | | | 12-50 | 12 (4K) | F/1.8 | 9.4 | 1/1.7" | 2 | 52 | 64.5 | 65 |
| SL1250P | ✓ | CS | ✓ | P | ✓ | | ✓ | | | | | | | | | | | | | | | | 69 |
| SL1250A | ✓ | CS | ✓ | A | ✓ | | ✓ | | | | | | | | | | | | | | | | 70 |

For more information contact

Theia Technologies
info@TheiaTech.com
www.TheiaTech.com
+1-503-570-3296

Revisions:

| Version | Change | Reason |
|----------------|-----------------------------------|--------------------------------------------------------------------------------------------------------|
| 220322 | Templated spec sheet | Family spec sheet can be reduced for each lens model to simplify spec sheet |
| 220401 | Alternate lens table | Corrected typo, added 2 -N6 versions |
| | Entrance pupil location | Added dimension for lens vertex relative to lens plastic |
| 220426 | Alternate lens table | Updated to delineate non-motorized versions |
| 230110 | Corrected TTL | Lens length didn't match drawing |
| | Added lens weight | Based on first production lenses |
| | Simplified alternate lens options | Removed -R6 and associated lenses |
| 230124 | Reversed FZ curve | Focus steps in FZ curve were reversed from motor moving directions and data in the key positions table |
| 230426 | Updated lens table | Added "-CS" to part numbers, general formatting |
| 230605 | IRC switching time | Added maximum switch time for IRC |
| 230817 | p.4 focus/zoom note | Clarified calibration requirement for focus/zoom curve |
| 240301 | 850nm filter spec | Spec listed as TBD previously |